

ISS	REVISED BY:	REVISION DATE	ECO #

NOTES:

MATERIAL:
PLATE - STEEL, 55 KSI YIELD

WELDING REQUIREMENTS:
ALL WELDING TO BE PERFORMED BY WELDERS CERTIFIED
UNDER SECTION 5 OF AWS D1.1

FINISH:
NONE

DIMENSIONS: INCHES

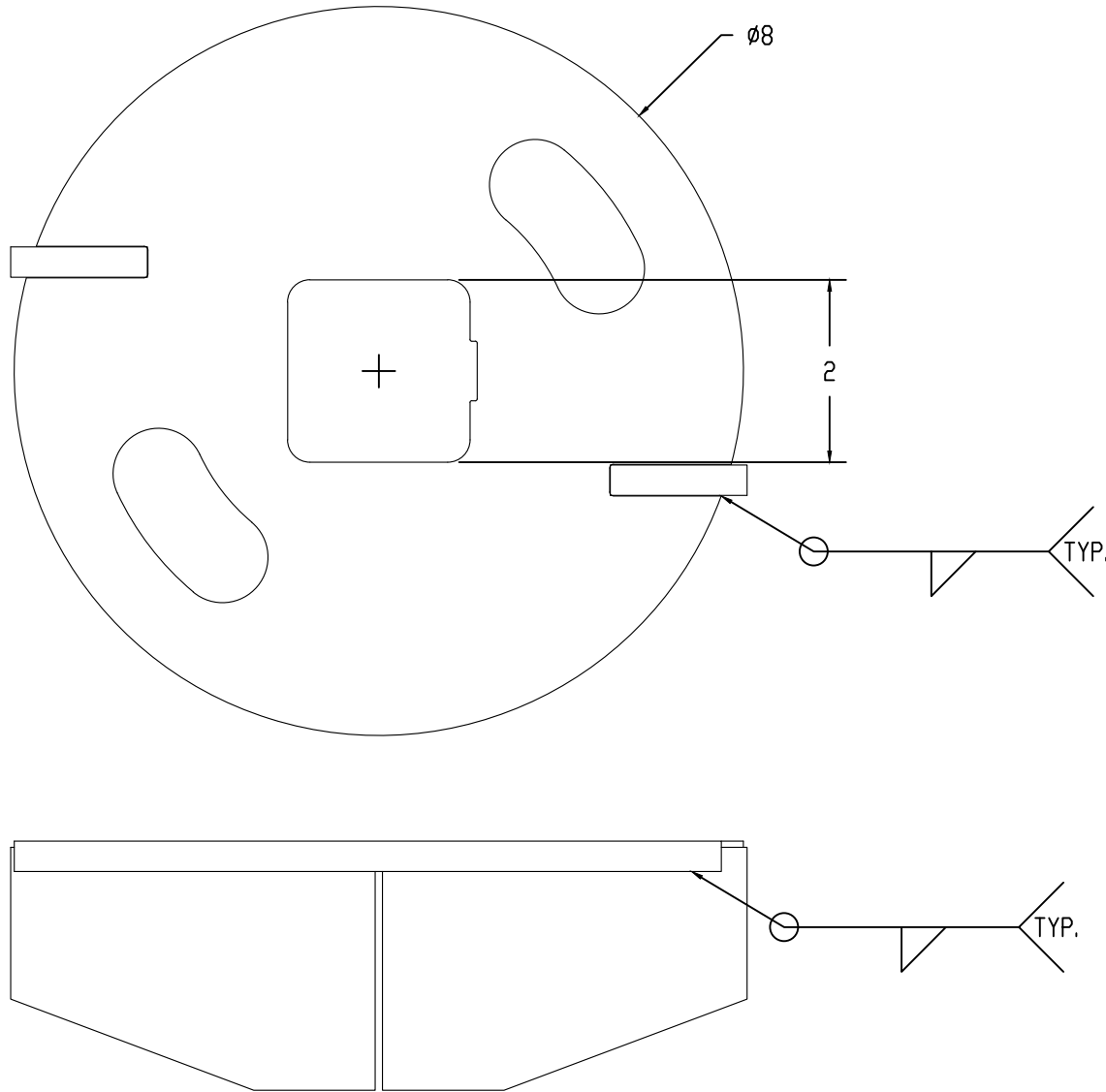

CATALOG NUMBER: MVP815		
SHEET NAME: Sheet1	1 OF 1	
DRAWING DESCRIPTION: 8" CUTTER PLATE FOR D15 PILES		
DRAWN BY: DH	DATE: 03/06/20	APPROVED: DR



WWW.MACLEANPOWER.COM

This drawing contains confidential information that is the property of MacLean Power, L.L.C. ("MacLean"). Use of MacLean's confidential information without MacLean's express written consent is strictly prohibited and may expose you to legal liability. If you believe that you received this material in error, please destroy it or return it to MacLean Power, L.L.C., Kingsley Park Five, 481 Munn Rd. Suite 300, Fort Mill, SC 29715, USA.